

FLAX EVO P 20 FSE

Technical Sheet

8" shallow subwoofer



SPECIFICATIONS

Nominal power	200W
Maximum power	400W
Sensitivity	86dB
Nom. impedance	4Ω
Cone	Flax
Surround	Rubber
DC resistance	3.2Ω
VC diameter	38mm 1½"
Former	Glass fiber
Layers	4
Wire	Copper
Net weight	2.2kg 4.4lbs

FREQUENCY RESPONSE/IMPEDANCE

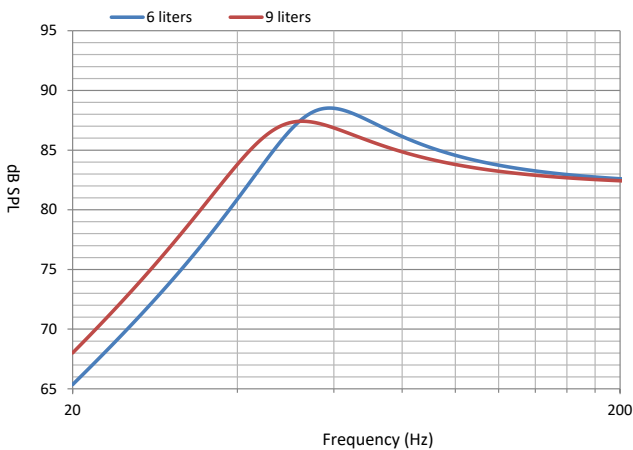

PARAMETERS

Rdc	3.2Ω
Fs	35Hz
Mms	150g
Cms	0.15mm/N
Vas	9l
Qts	1.3
Qes	1.8
Qms	5
Bxl	7.6N/A
Sd	213cm ²
SPL	82dB
Xmax	11mm

MECHANICAL DRAWING

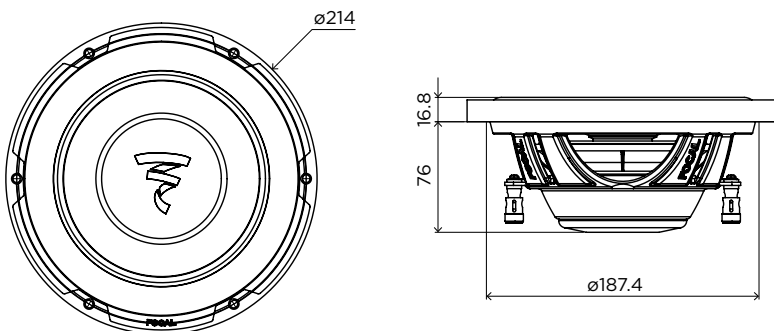

SUGGESTED APPLICATION

Sealed enclosure

Volume	F-3 (Hz)
6L (0.21 cu.ft.)	54Hz
9L (0.32 cu.ft.)	49Hz