

MOTORITIES COLLECTION

2023



FOCAL[®] *INSIDE*



For the past four decades, Focal has been stamping its unique sound signature on high-end speaker drivers and acoustic loudspeakers.

The brand's values are innovation and performance, excellence and pleasure. We are renowned the world over for our exclusive technologies. The result of this technological heritage is a sound reproduction imbued with clarity, power and a natural quality, presenting you with the best products in their category.

With the Focal Inside range, we deliver Plug & Play solutions that are perfectly suited to and easy to install in a large number of car models.

Create the sound experience of your dreams.



01.

FOCAL INSIDE

7



02.

SUBWOOFERS

47



03.

CABLES
& ELECTRONICS

53

01.

FOCAL[®] *INSIDE*

One car, one audio solution

The Focal Inside range is aimed at all drivers who wish to replace their original car audio system with a quality hi-fi Plug & Play solution that is easy to install without modifying the environment. Different configurations are available for each car make (more than 40 makes) and each model (800 vehicle models), and the mounting accessories are included in each kit. For optimal performance, amplification solutions complete our offering. Configure the solution of your dreams in just a few clicks.



www.focal-inside.com



911

Panamera

Cayenne

Taycan





P60 TW



P60 MED





P60 WF

Type	2 x Inverted dome tweeter	3 x Medium	2 x Woofers
Diameter	1½" (42 mm)	4" (100mm)	4" (100mm)
Magnet	Neodymium	Neodymium	Neodymium
Cone	Beryllium	'W'	'W'
Impedance	3.1 Ω	3.1 Ω	3.1 Ω
Max. power	100W	100W	200W
Nom. power	15W	50W	100W
Sensitivity (2.83 V/1m)	93.5dB	87dB	91dB
Frequency response	2.4kHz - 40kHz	150Hz - 2500Hz	35Hz - 500Hz

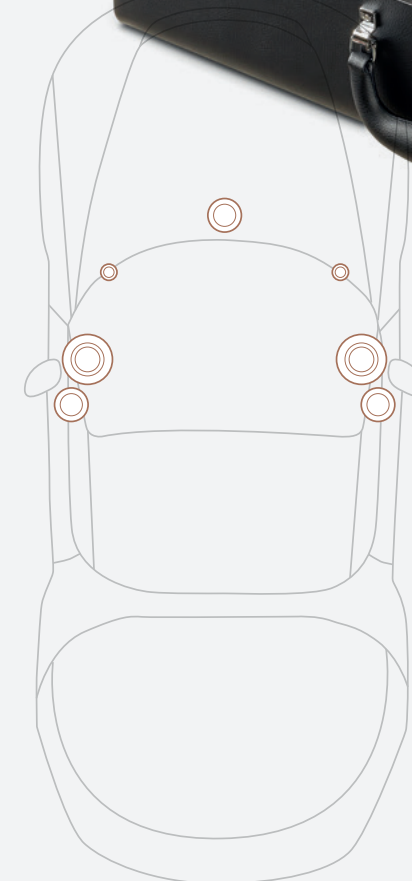
KIT P60 LIMITED EDITION



-  Tweeter
-  Midrange
-  Subwoofer



C-Class

E-Class

S-Class

GLC





ICC MBZ 100

IC MBZ 100

ICR MBZ 100

IS MBZ 100

	ICC MBZ 100	IC MBZ 100	ICR MBZ 100	IS MBZ 100
Type	Central speaker with eCall function	2-way coaxial kit	2-way surround coaxial kit	2-way component kit
Diameter	4" (100mm)	4" (100mm)	4" (100mm)	4" (100mm)
Magnet	Neodymium	Neodymium	Neodymium	Neodymium
Cone	Flax	Flax	Flax	Flax
Impedance	2 x 4Ω	4Ω	4Ω	4Ω
Tweeter	-	Compact ¾" (20.5mm) tweeter	Compact ¾" (20.5mm) tweeter	Aluminium inverted dome tweeter
Max. power	50W x 2	80W	80W	100W
Nom. power	25W RMS x 2	40W RMS	40W RMS	50W RMS
Sensitivity (2.83 V/1m)	82.7dB	88dB	88dB	87dB
Frequency response	150Hz - 20kHz	150Hz - 20kHz	150Hz - 20kHz	150Hz - 20kHz
Accessories	Supplied with mounting accessories	Supplied with mounting accessories	Supplied with mounting accessories	Supplied with mounting accessories



ISUB MBZ 2 & ISUB MBZ 2 RHD

Subwoofers kit
Two versions : left and right hand drive

8" (200mm)

Neodymium

Polyglass

2Ω

150W x 2

75W RMS x 2

93.3dB

35Hz - 200Hz

Supplied with mounting accessories

FOCAL SUGGESTS

You can install speaker drivers on their own, or choose an amplified installation to offer the best performance. We suggest:

- 1 x Impulse 4.320
- 1 x Front kit*
- 1 x ISUB MBZ 2 or ISUB MBZ 2 RHD
- 1 x Y-ISO MBZ
- 1 x IW IMP 2.2
- 1 x Power supply

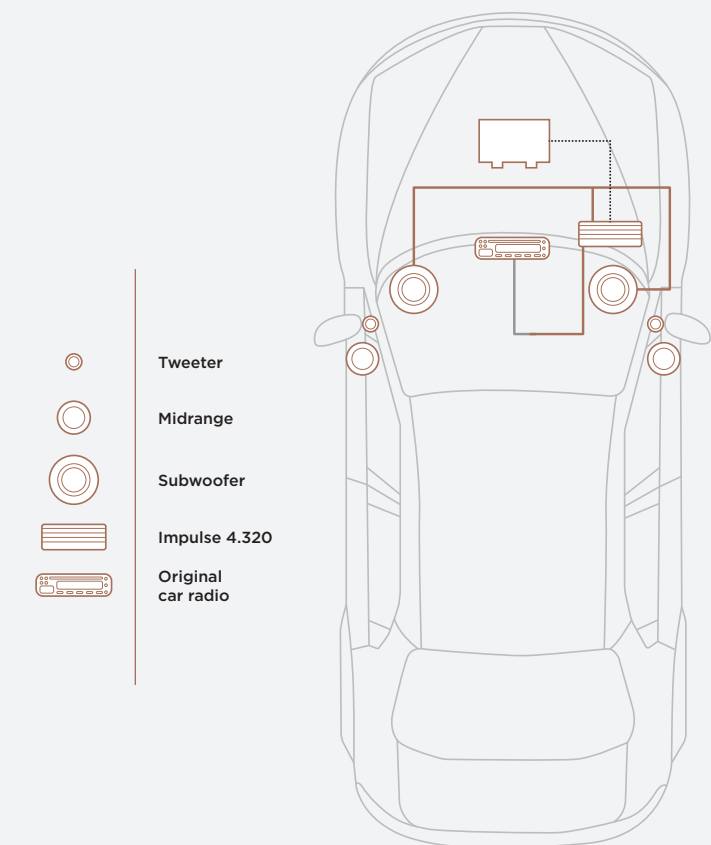

FOR A COMPLETE EXPERIENCE

If your vehicle is compatible, replace your central, rear and surround speaker drivers, too!

* Check the models required at: www.focal-inside.com



1 Serie	Z4
2 Serie	BMW X1
3 Serie	BMW X2
4 Serie	BMW X3
5 Serie	BMW X4
6 Serie	BMW X5
7 Serie	BMW X6
i3	BMW X7
i8	



3-door
5-door
Countryman
Clubman
Cabrio
Roadster
Convertible
Paceman





	ICC BMW 100	IC BMW 100	IC BMW 100L	IS BMW 100
Type	2-way coaxial central kit	2-way coaxial kit	2-way coaxial kit	2-way component kit
Diameter	4" (100mm)	4" (100mm)	4" (100mm)	4" (100mm)
Magnet	Neodymium	Neodymium	Neodymium	Neodymium
Cone	Polyglass	Polyglass	Polyglass	Polyglass
Impedance	4Ω	4Ω	4Ω	4Ω
Tweeter	Aluminium/ Magnesium inverted dome tweeter	Aluminium/ Magnesium inverted dome tweeter	Aluminium/ Magnesium inverted dome tweeter	Aluminium/ Magnesium inverted dome tweeter
Max. power	80W	80W	80W	80W
Nom. power	40W RMS	40W RMS	40W RMS	40W RMS
Sensitivity (2.83 V/1m)	89.5dB	89.5dB	89.5dB	89.5dB
Frequency response	90Hz - 23kHz	80Hz - 23kHz	80Hz - 23kHz	80Hz - 23kHz
Accessories	Supplied with mounting accessories	Supplied with mounting accessories	Supplied with mounting accessories	Supplied with mounting accessories



	IS BMW 100L	ISUB BMW 2	ISUB BMW 4
Type	2-way component kit	Subwoofer	Subwoofer
Diameter	4" (100mm)	8" (200mm)	8" (200mm)
Magnet	Neodymium	Neodymium	Neodymium
Cone	Polyglass	Polyglass	Polyglass
Impedance	4Ω	2Ω	4Ω
Tweeter	Aluminium/ Magnesium inverted dome tweeter	-	-
Max. power	80W	180W	180W
Nom. power	40W RMS	90W RMS	90W RMS
Sensitivity (2.83 V/1m)	89.5dB	86dB	86dB
Frequency response	80Hz - 23kHz	35Hz - 200Hz	35Hz-200Hz
Accessories	Supplied with mounting accessories	Supplied with mounting accessories	Supplied with mounting accessories



For BMW X5 and BMW X6 models, KIAC 1122 brackets (spacers) need to be used.

KIAC 1122

FOCAL SUGGESTS

You can install speaker drivers on their own, or choose an amplified installation to offer the best speaker driver performance.

We suggest:

- 1 x Impulse 4.320
- 1 x Front kit*
- 2 x ISUB BMW 4
- 1 x BMW IMP-2.1
- 1 x Power supply

FOR A COMPLETE EXPERIENCE

If your vehicle is compatible, replace your central, rear and surround speaker drivers, too!

- 1 x Front kit*
- 1 x Rear kit*
- 1 x Surround Kit*
- 1 x ICC BMW 100*
- 2 x ISUB BMW 4

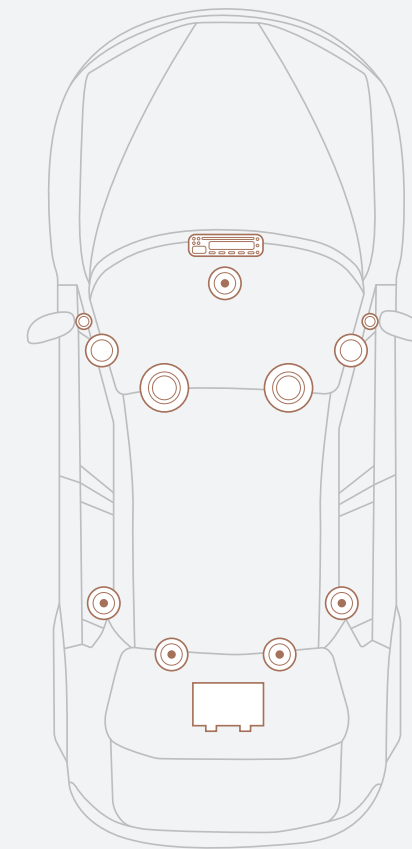
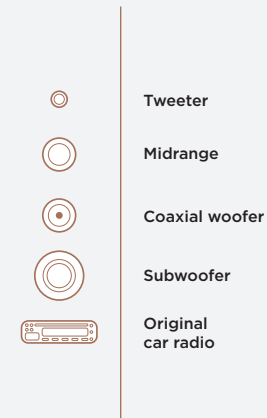
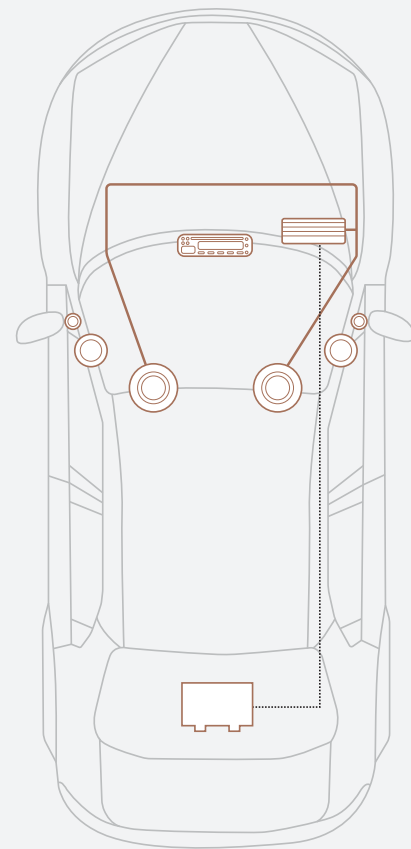
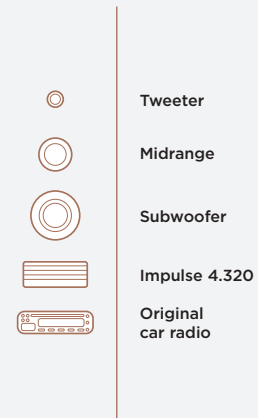

FOR A COMPLETE EXPERIENCE

If your vehicle is compatible, replace your central, rear and surround speaker drivers, too!

* Check the models required at: www.focal-inside.com

* Check the models required at: www.focal-inside.com



Kuga
Ranger
F-Series
Focus
Fiesta



MKX
Navigator





IC FORD 165

IC FORD 690

IS FORD 165

Type	2-way coaxial kit	2-way coaxial kit	2-way component kit
Diameter	6½" (165mm)	6 x 9" (150 x 230mm)	6½" (165mm)
Magnet	Ferrite	Ferrite	Ferrite
Cone	Polyglass	Polyglass	Polyglass
Impedance	4Ω	4Ω	4Ω
Tweeter	Aluminium inverted dome tweeter	Aluminium inverted dome tweeter	Aluminium inverted dome tweeter
Max. power	120W	150W	120W
Nom. power	60W RMS	75W RMS	60W RMS
Sensitivity (2.83 V/1m)	92.5dB	92dB	91.7dB
Frequency response	60Hz - 20kHz	60Hz - 20kHz	60Hz - 20kHz
Accessories	Supplied with mounting accessories	Supplied with mounting accessories	Supplied with mounting accessories



IS FORD 690

Type	2-way component kit
Diameter	6 x 9" (150 x 230mm)
Magnet	Ferrite
Cone	Polyglass
Impedance	4Ω
Tweeter	Aluminium inverted dome tweeter
Max. power	150W
Nom. power	75W RMS
Sensitivity (2.83 V/1m)	92.3dB
Frequency response	50Hz - 20kHz
Accessories	Supplied with mounting accessories

FOCAL SUGGESTS

You can install speaker drivers on their own, or choose an amplified installation to offer the best performance. We suggest:

- 1 x Impulse 4.320
- 1 x Front kit*
- 1 x Rear kit*
- 1 x Y-ISO FORD*
- 1 x IMP EXT150
- 1 x Power supply

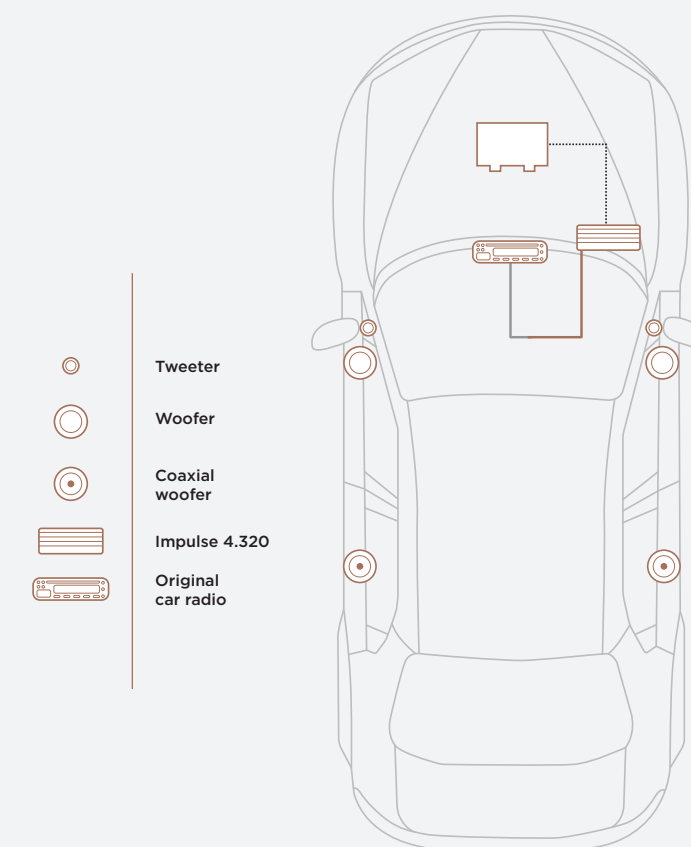

FOR A COMPLETE EXPERIENCE

If your vehicle is compatible, replace your rear speaker drivers, too!

* Check the models required at: www.focal-inside.com



- Mii
- Arosa
- Ibiza
- Leon
- Altea
- Toledo

ŠKODA



- Citigo
- Fabia
- Octavia
- Superb
- Roomster



- | | |
|----------|--------|
| Lupo | Bora |
| Up! | Vento |
| Polo | Jetta |
| Beetle | Passat |
| Scirocco | Tiguan |
| Eos | Touran |
| Golf | Amarok |
| Lavida | |





IC VW 165

Type	2-way coaxial kit	IS VW 155	2-way component kit	IS VW 165	2-way component kit
Diameter	6½" (165mm)		6" (155mm)		6½" (165mm)
Magnet	Ferrite		Ferrite		Ferrite
Cone	Polyglass		Polyglass		Polyglass
Impedance	2Ω		2Ω		2Ω
Tweeter	Aluminium inverted dome tweeter		Aluminium inverted dome tweeter		Aluminium inverted dome tweeter
Max. power	120W		100W		120W
Nom. power	60W RMS		50W RMS		60W RMS
Sensitivity (2.83 V/1m)	93.7dB		92dB		93.7dB
Frequency response	60Hz - 20kHz		70Hz - 20kHz		60Hz - 20kHz
Accessories	Supplied with mounting accessories		Supplied with mounting accessories		Supplied with mounting accessories



IS VW 155



IS VW 165



IS VW 180

Type	2-way component kit
Diameter	7" (180mm)
Magnet	Ferrite
Cone	Polyglass
Impedance	2Ω
Tweeter	Aluminium inverted dome tweeter
Max. power	150W
Nom. power	75W RMS
Sensitivity (2.83 V/1m)	94dB
Frequency response	50Hz - 20kHz
Accessories	Supplied with mounting accessories

FOCAL SUGGESTS

You can install speaker drivers on their own, or choose an amplified installation to offer the best performance. We suggest:

- 1 x Impulse 4.320
- 1 x Front kit*
- 1 x Rear kit*
- 1 x Y-ISO VW*
- 1 x IMP EXT150
- 1 x Power supply

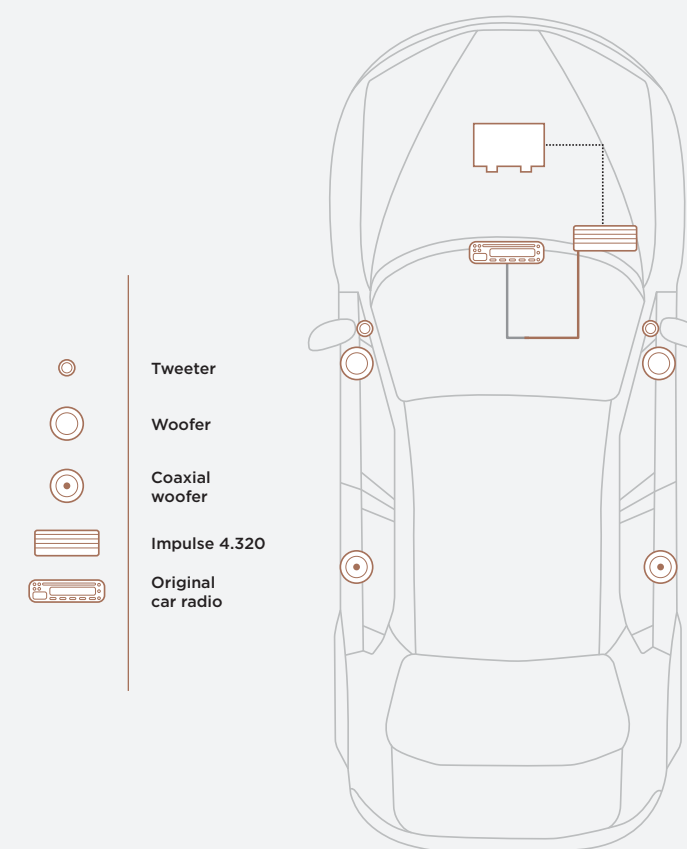

FOR A COMPLETE EXPERIENCE

If your vehicle is compatible, replace your rear speaker drivers, too!

* Check the models required at: www.focal-inside.com



- CT
- GX
- LX
- RX
- ES
- IS



- BRZ
- Crosstrek
- Impreza IV
- WRX
- Outback
- Forester



- FR-S
- xB
- iQ
- xA
- xD
- tC

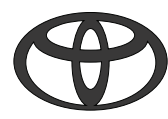

- | | |
|---------------|------------------|
| iQ | RAV4 |
| Aygo | C-HR |
| Etios
Liva | Urban
Cruiser |
| Yaris | FJ Cruiser |
| Vitz | Fortuner |
| Prius | Hilux |
| Camry I | Tundra |
| Corolla II | Tacoma |
| Celica | Echo |
| GT86 | Matrix |
| SW4 | |

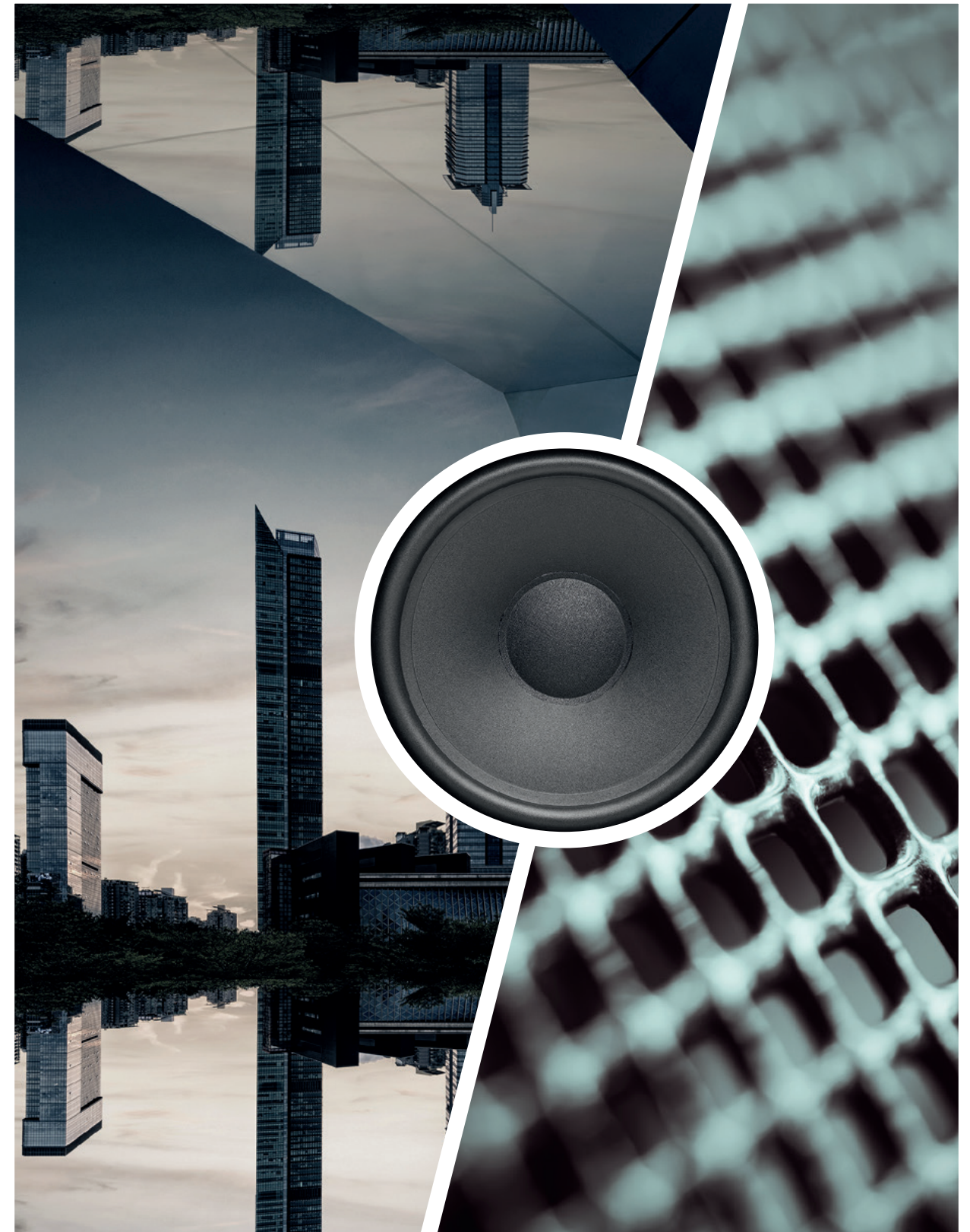



IC TOY 165

IS TOY 690

IS TOY 165

Type	2-way coaxial kit	2-way elliptical component kit	2-way component kit
Diameter	6½" (165mm)	6 x 9" (150 x 230mm)	6½" (165mm)
Magnet	Ferrite	Ferrite	Ferrite
Cone	Polyglass	Polyglass	Polyglass
Impedance	4Ω	4Ω	4Ω
Tweeter	Aluminium inverted dome tweeter	Aluminium inverted dome tweeter	Aluminium inverted dome tweeter
Max. power	120W	150W	120W
Nom. power	60W RMS	75W RMS	60W RMS
Sensitivity (2.83 V/1m)	92.5dB	92.3dB	91.7dB
Frequency response	60Hz - 20kHz	50Hz - 20kHz	60Hz - 20kHz
Accessories	Supplied with mounting accessories	Supplied with mounting accessories	Supplied with mounting accessories



IS TOY 165 TWU

2-way component kit
(with Universal tweeters)

6½" (165mm)

Ferrite

Polyglass

4Ω

Aluminium/Magnesium inverted dome tweeter

120W

60W RMS

91.7dB

60Hz - 20kHz

Supplied with mounting accessories

FOCAL SUGGESTS

You can install speaker drivers on their own, or choose an amplified installation to offer the best performance. We suggest:

- 1 x Impulse 4.320
- 1 x Front kit*
- 1 x Rear kit*
- 1 x Y-ISO TOY*
- 1 x IMP EXT150
- 1 x Power supply

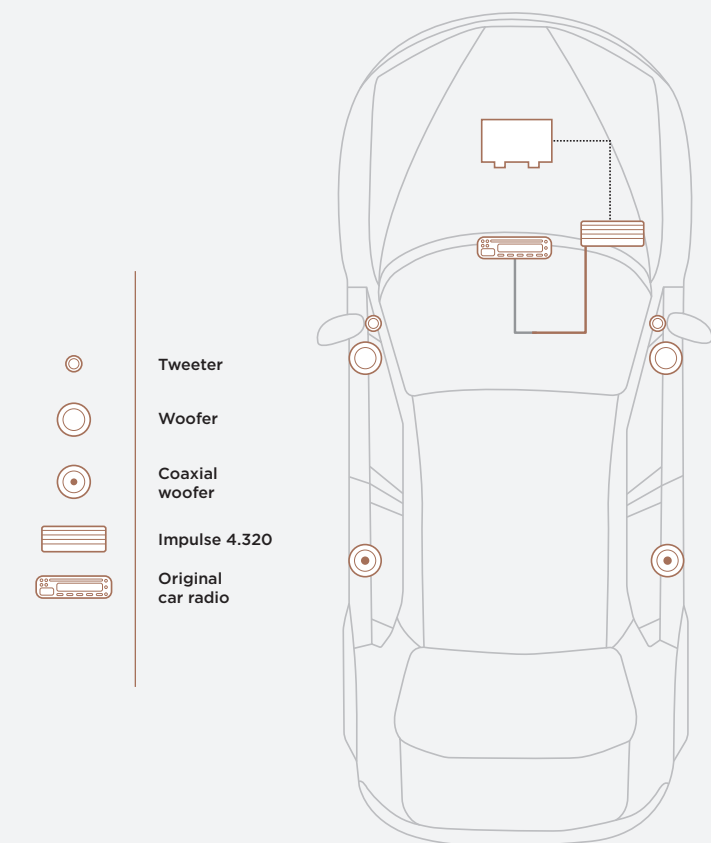

FOR A COMPLETE EXPERIENCE

If your vehicle is compatible, replace your rear speaker drivers, too!

* Check the models required at:
www.focal-inside.com



- Twingo
- Clio
- Zoe
- Wind
- Megane
- Fluence
- Laguna
- Latitude
- Talisman
- Modus
- Scenic
- Grand Scenic
- Captur
- Kadjar
- Koleos
- Alaskan
- Kangoo
- Trafic
- Master



- Fortwo
- Forfour



- Micra
- March
- Versa
- Pulsar
- Juke
- Kicks
- Qashqai
- X-Trail
- Rogue
- Frontier
- Titan
- Pathfinder
- Murano
- Navara
- NV200
- NV300
- NP200
- NP300



- Talento
- Talento VU



- SM3
- SM5
- SM6
- SM7
- QM3
- QM6

DACIA

- Sandero
- Logan
- Dokker
- Duster
- Lodgy



- Vesta
- Largus
- XRAY





IC REN 130

IC RNS 165

IS RNI 690

IS REN 130

Type	2-way coaxial kit	2-way coaxial kit	2-way elliptical component kit	2-way component kit
Diameter	5" (130mm)	6½" (165mm)	6 x 9" (150 x 230mm)	5" (130mm)
Magnet	Ferrite	Ferrite	Ferrite	Neodymium
Cone	Polyglass	DFS® fiberglass	Polyglass	Polyglass
Impedance	4Ω	4Ω	4Ω	4Ω
Tweeter	Aluminium inverted dome tweeter	Aluminium inverted dome tweeter	Aluminium inverted dome tweeter	Aluminium inverted dome tweeter
Max. power	120W	120W	160W	100W
Nom. power	60W RMS	60W RMS	80W RMS	50W RMS
Sensitivity (2.83 V/1m)	91.8dB	91dB	93.6dB	91.7dB
Frequency response	75Hz - 20kHz	60Hz - 20kHz	55Hz - 21kHz	80Hz - 28kHz
Accessories	Supplied with mounting accessories	Supplied with mounting accessories	Supplied with mounting accessories	Supplied with mounting accessories



IS RNS 165

2-way component kit

6½" (165mm)

Neodymium

Polyglass

4Ω

Aluminium inverted dome tweeter

120W

60W RMS

92.7dB

60Hz - 28kHz

Supplied with mounting accessories

FOCAL SUGGESTS

You can install speaker drivers on their own, or choose an amplified installation to offer the best performance. We suggest:

- 1 x Impulse 4.320
- 1 x Front kit*
- 1 x Rear kit*
- 1 x Y-ISO REN/NIS
- 1 x IMP EXT150
- 1 x Power supply

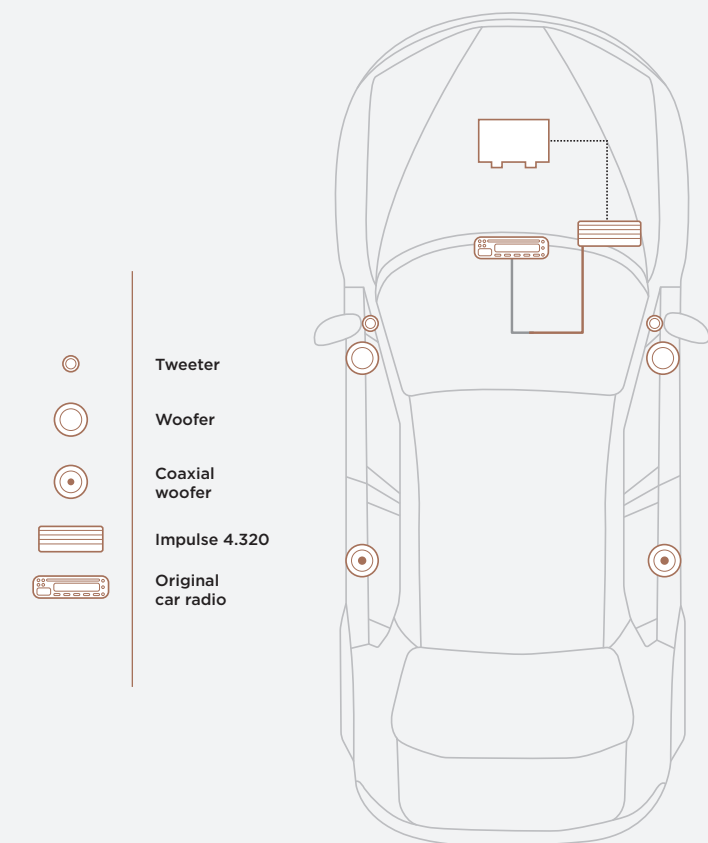

FOR A COMPLETE EXPERIENCE

If your vehicle is compatible, replace your rear speaker drivers, too!

* Check the models required at: www.focal-inside.com



C3
C4
C4 Cactus
Cactus
C5 Aircross
Berlingo
SpaceTourer
Jumpy



DS3
DS3 CROSSBACK
DS4
DS5
DS7 CROSSBACK



Grandland X
Combo
Zafira
Vivaro
Corsa F



206	2008
207	3008
208	5008
307	RCZ
308	Traveller
407	Expert
508	Rifter





IC PSA 165

IS PSA 165

IFP 207

Type	2-way coaxial kit	2-way component kit	2-way component kit
Diameter	6½" (165mm)	6½" (165mm)	6½" (165mm)
Magnet	Ferrite	Ferrite	Ferrite
Cone	Polyglass	Polyglass	Polyglass
Impedance	4Ω	4Ω	4Ω
Tweeter	Aluminium/Magnesium inverted dome tweeter	Aluminium/Magnesium inverted dome tweeter	TNB Aluminium/Magnesium inverted dome tweeter
Max. power	140W	140W	140W
Nom. power	70W RMS	70W RMS	70W RMS
Sensitivity (2.83 V/1m)	93.2dB	92.6dB	92.7dB
Frequency response	60Hz - 20kHz	60Hz - 20kHz	70Hz - 25kHz
Accessories	Supplied with mounting accessories	Supplied with mounting accessories	Supplied with mounting accessories

FOCAL SUGGESTS

You can install speaker drivers on their own, or choose an amplified installation to offer the best performance. We suggest:

- 1 x Impulse 4.320
- 1 x Front kit*
- 1 x Rear kit*
- 1 x Y-ISO PSA
- 1 x IMP EXT150
- 1 x Power supply

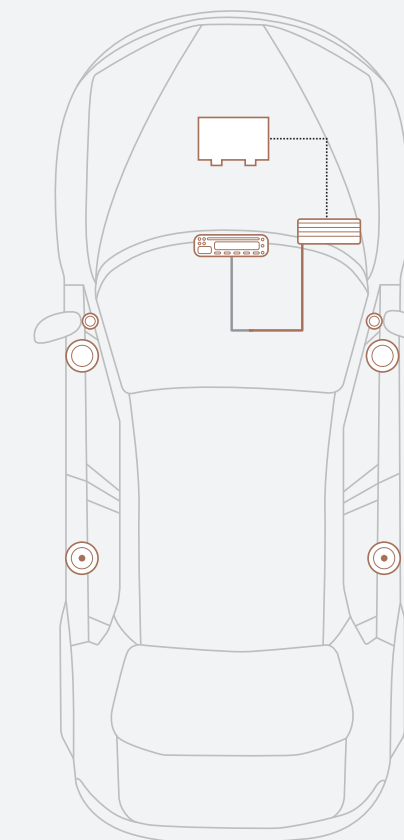

FOR A COMPLETE EXPERIENCE

If your vehicle is compatible, replace your rear speaker drivers, too!

* Check the models required at: www.focal-inside.com

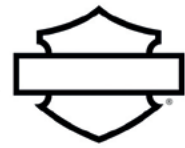

Road Glide
Electra Glide
Street Glide
Batwing
fairings

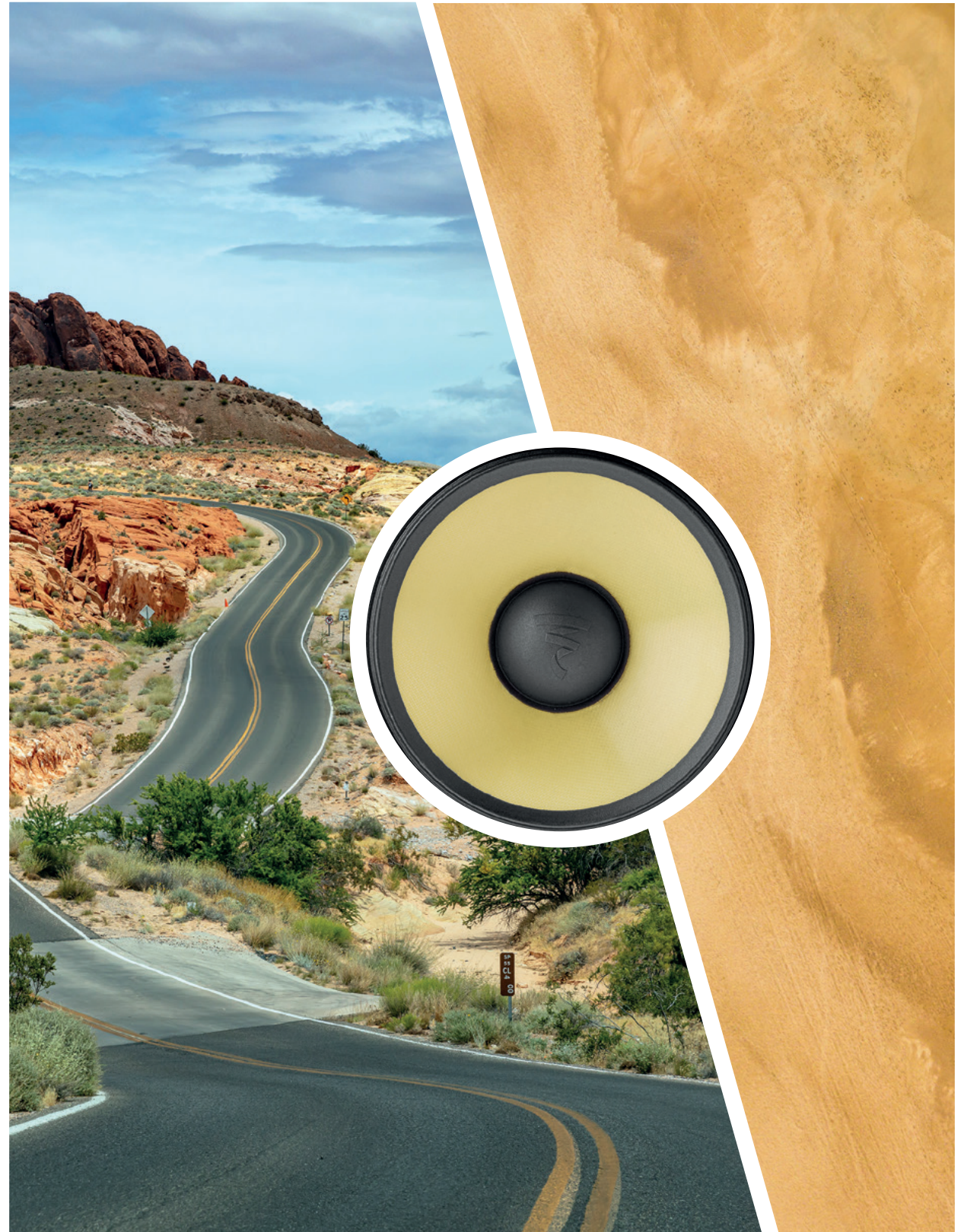



HDA 165 - 98/2013

HDA 165 - 2014 UP

Type	2-way component kit	2-way component kit
Diameter	6½" (165mm)	6½" (165mm)
Magnet	Ferrite	Ferrite
Cone	Fiberglass DFS®	Fiberglass DFS®
Impedance	4Ω	4Ω
Tweeter	Compression inverted dome tweeter	Compression inverted dome tweeter
Max. power	160W	160W
Nom. power	80W RMS	80W RMS
Sensitivity (2.83 V/1m)	91dB	91dB
Frequency response	70Hz - 22kHz	70Hz - 22kHz
Accessories	Supplied with mounting accessories	Supplied with mounting accessories



HDK 165 - 98/2013

HDK 165 - 2014 UP

Type	2-way component kit	2-way component kit
Diameter	6½" (165mm)	6½" (165mm)
Magnet	Ferrite	Ferrite
Cone	K2	K2
Impedance	2Ω	2Ω
Tweeter	M-profile compression tweeter	M-profile compression tweeter
Max. power	250W	250W
Nom. power	125W RMS	125W RMS
Sensitivity (2.83 V/1m)	92.5dB	92.5dB
Frequency response	60Hz - 21kHz	60Hz - 21kHz
Accessories	Supplied with mounting accessories	Supplied with mounting accessories



For Road Glide models from 1998 to 2013, the KIAC 1135 needs to be used.

KIAC 1135

02.

SUBWOOFERS

To enjoy impactful bass, our engineers have designed the ISUB TWIN and PSB200 passive subwoofers and the ISUB ACTIVE and ISUB ACTIVE 2.1 amplified subwoofers. The ISUB TWIN are ultra-compact, can handle up to 100 watts RMS each, and are easy to install beneath the seats. They are optimised to be connected to the Impulse 4.320 amplifier (see *chapter 3*) but also combine very well with the Focal Inside solutions and traditional Focal products. PSB200 is compact and robust, offering 250 watts of power and sliding easily into a car boot. The ISUB ACTIVE subwoofers deliver 260 watts of power and are the perfect addition to a Focal Inside audio system. ISUB ACTIVE 2.1 incorporates a 2-channel amplifier to amplify the vehicle's front speakers.





PSB200

ISUB TWIN

Type	Compact passive subwoofer	Ultracompact passive subwoofers
Impedance	4Ω	2 x 2Ω
Max. power (2Ω)	250W	2 x 200W
Max. power (bridgé 4Ω)	150W RMS	2 x 100W RMS
Sensitivity (2.83 V / 1m)	83dB	83dB
Frequency response	45Hz - 150Hz	50Hz - 150Hz
Accessories	Velcro, screws, mounting accessories	Velcro
Weight	15.4lbs (7kg)	2 x 5.9lbs (2 x 2.7kg)
Dimensions (WxHxD)	19¼ x 4⅝ x 12" (48.9 x 10.9 x 30.4cm)	10¼ x 3⅝ x 9½" (26 x 8 x 24cm)

FOCAL SUGGESTS

You can install speaker drivers on their own, or choose an amplified installation to offer the best performance. We suggest:

1 x Impulse 4.320
 1 x PSB200
 1 x Y-ISO BRAND
 1 x IW IMP-2.1
 1 x Power supply

1 x Impulse 4.320
 1 x ISUB TWIN
 1 x Y-ISO BRAND
 1 x IW IMP-2.2
 1 x Power supply

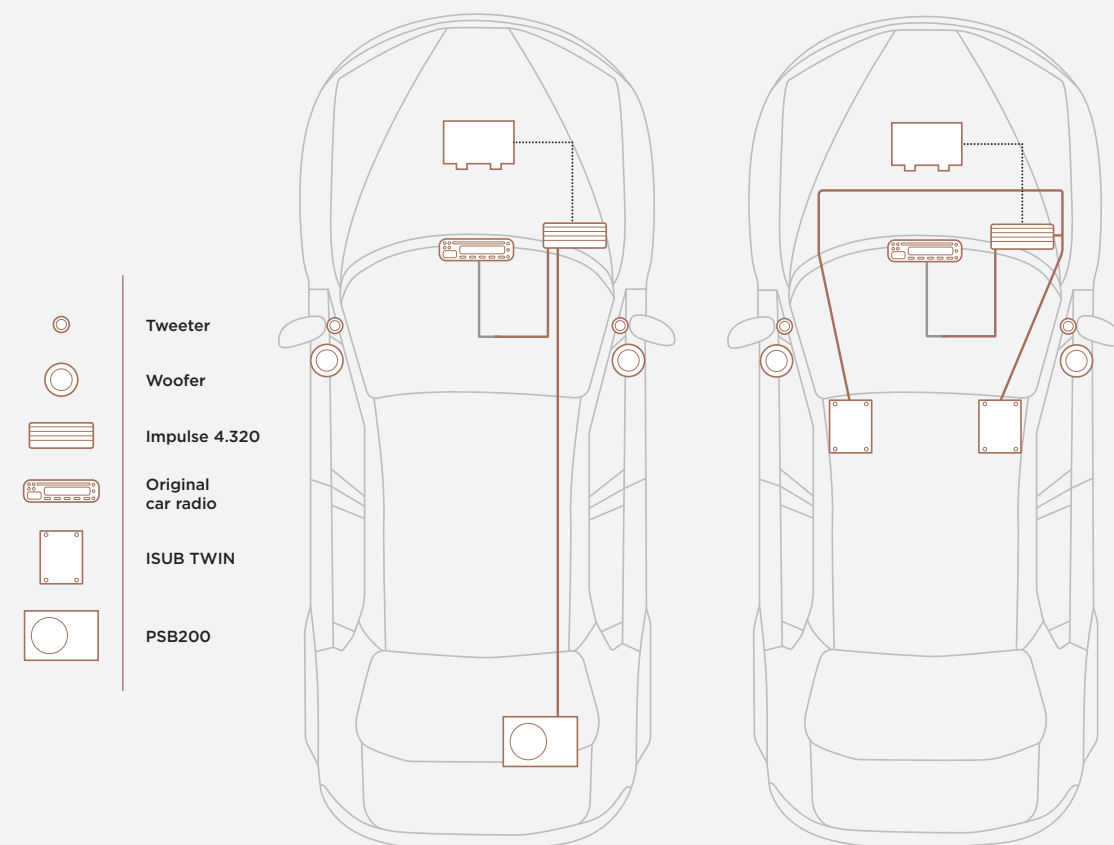

FOR A COMPLETE EXPERIENCE

If your vehicle is compatible, replace your rear and surround speaker drivers, too!

* Check the models required at:
www.focal-inside.com



ISUB ACTIVE

ISUB ACTIVE 2.1

Type	Ultra-compact amplified subwoofer	Ultra-compact amplified subwoofer & 2-channel amplifier
Impedance	4Ω	4Ω
Diameter	8" (200mm)	8" (200mm)
Max. power	260W	260W
Nom. power	130W RMS	130W RMS
Fuse rating	20A	35A
Subwoofer phase	0 or 180°	0 or 180°
SNR	> 80dBA	> 80dBA
Max. power amplifier	-	2 x 110W
Nom. power amplifier	-	2 x 55W RMS
Frequency response	45Hz - 150Hz	45Hz - 150Hz
Weight	9.6lbs (4.25kg)	9.6lbs (4.25kg)
Dimensions (WxHxD)	12 ⁷ / ₈ x 2 ¹ / ₂ x 9 ¹ / ₁₆ " (32.8 x 6.3 x 23cm)	12 ⁷ / ₈ x 2 ¹ / ₂ x 9 ¹ / ₁₆ " (32.8 x 6.3 x 23cm)

FOCAL SUGGESTS

You can install speaker drivers on their own, or choose an amplified installation to offer the best performance. We suggest:

1 x ISUB ACTIVE 2.1
1 x Power Supply

1 x Impulse 4.320
1 x ISUB ACTIVE
1 x Y-ISO BRAND
1 x IMP EXTENSION I/O 150
1 x Power Supply

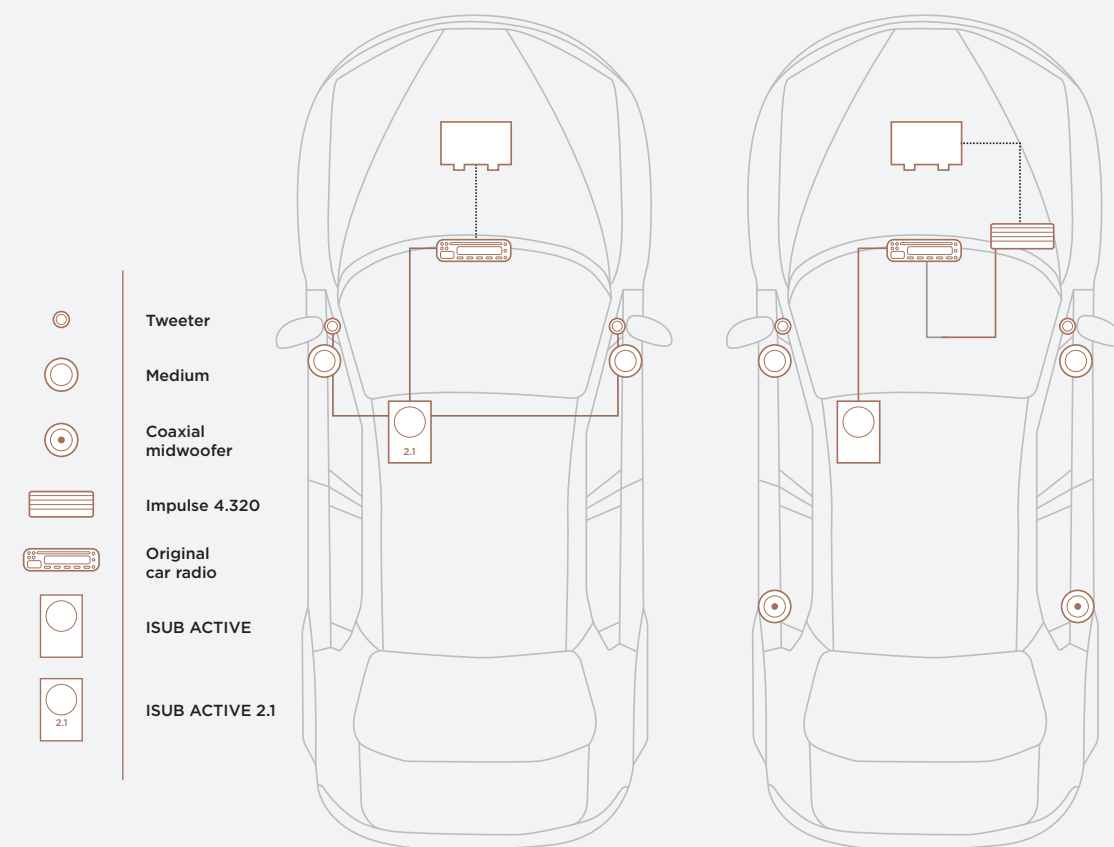

FOR A COMPLETE EXPERIENCE

If your vehicle is compatible, replace your rear and surround speaker drivers, too!*

* Check the models required at: www.focal-inside.com

03.

CABLES & ELECTRONICS

To benefit from a dynamic and efficient system, the Impulse 4.320 digital amplifier and Focal Inside cables complete our solutions. Impulse 4.320 is compact, with 4 channels each delivering 55 watts and enabling the speaker drivers to express their full potential. Optimising the connections between car radio, electronics and acoustics, the dedicated Focal Inside cables play their own essential role in your audio architecture. Adaptation cables, extension cables, connection cables, direct power cables, impedance simulator, and more: they guarantee the performance and safety of your installation.





IMPULSE 4.320

Type	D-Class ultra-compact Amplifier - 4/3/2 channels
CEA power(4Ω)	4 x 55W RMS
Max. power (2 Ω)	4 x 80W RMS
Max. power (bridged 4 Ω)	2 x 160W RMS
Crossovers	Activable/deactivable fixed at 75Hz on channels 1/2 Configurable from 40Hz-200Hz on channels 3/4
Copy mode	4CH/2CH
Setting	Adjustable phase 0/180° on channel 3/4
Protections	Short circuit / Over-current / Reverse polarity / DC / Voltage drop / Heat protection
Weights	1.2lbs (550g)
Dimensions (WxHxD)	6 ⁷ / ₈ x 1 ⁷ / ₈ x 2 ⁵ / ₈ " (175 x 47 x 66.5mm)

Find the cables designed for your vehicle at:

www.focal-inside.com



IMP EXT I/O 150	IW IMP 2.1	IW IMP 2.2	IW BMW IMP 2.1	SPEAKER SIM	IMP POWER SUPPLY SET
Impulse 4.320 extension cable	Impulse 4.320 subwoofer harness	Impulse 4.320 Dual subwoofers harness	BMW speaker driver connection cable	Impedance simulator	Impulse 4.320 Power supply set



IW BMW Y-ISO	IW FORD Y-ISO	IW FORD Y-ISO V2	IW MBZ Y-ISO	IW NIS Y-ISO
Y-ISO BMW harness	Y-ISO Ford harness	Y-ISO Ford harness	Y-ISO Mercedes-Benz harness	Y-ISO Nissan harness



IW PSA Y-ISO	IW REN Y-ISO	IW TOY Y-ISO	IW TOY Y-ISO V2	IW VW Y-ISO
Y-ISO PSA harness	Y-ISO Renault harness	Y-ISO Toyota harness	Y-ISO Toyota harness	Y-ISO Volkswagen harness

COLLECTIONS

Combining performance and design, Focal's collections are a revelation, awakening the emotions through a supreme listening experience. And it doesn't matter where you are. At home with traditional and in-wall/in-ceiling loudspeakers, Home Cinema systems and open-back headphones; on the go with closed-back headphones and in-car kits; in the studio with professional monitors; and even at sea with specialist yacht solutions.



Home Collection



Motorities Collection



Professional Collection

FOCAL *Powered by* naim

Enjoy an incredible sound experience

Find our products in 10,000 retail partner stores across the world, but also in our Focal Powered by Naim shops. These shops, dedicated to our brands, invite you to dive into our world, our savoir-faire and immerse yourself in the Focal & Naim sound.

ASIA

Beijing - Bengaluru
Guangzhou
Petaling Jaya
Seoul Gangnam-gu
Seoul Hanam
Taipei

AUSTRALIA

Adélaide - Melbourne
Perth - Sydney

EUROPE

Cannes - Lyon - Monaco
Perpignan
Baden-Baden
Berlin - Bad Schwartau
Sevenoaks - Norwich
Prague
Bucarest
Budapest
Warsaw
Vilnius

CANADA

Barrie - Lethbridge
Saskatoon
Winnipeg

USA

Austin - Dallas - Houston
Las Vegas
Miami - Newport Beach
Scottsdale
Timonium

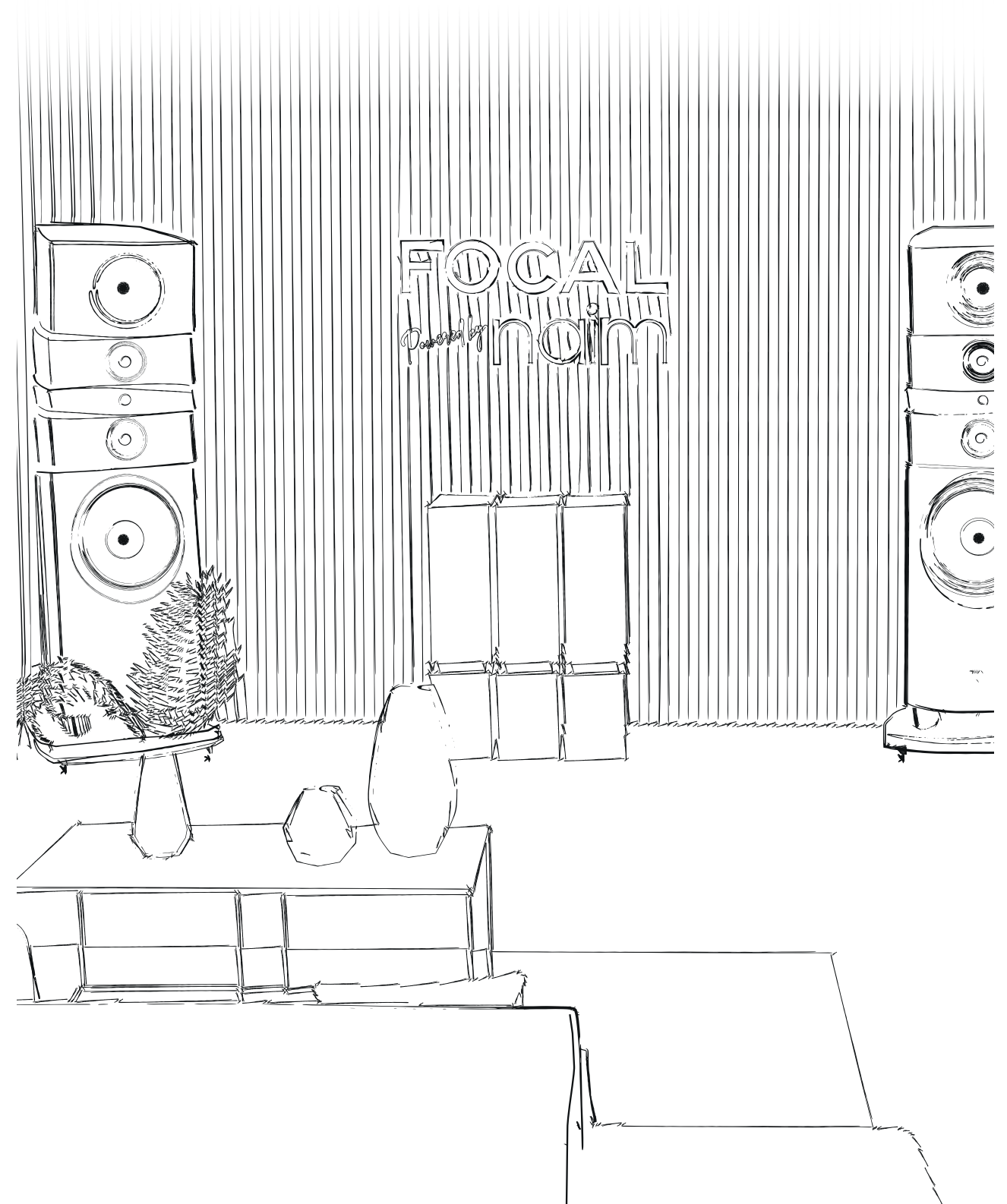



Create your sound experience on:

www.focal-inside.com

Find all our installation videos on:



Focal-JMlab®

BP 374 - 108, rue de l'Avenir - 42353 La Talaudière cedex - France - +33 (0) 477 435 700

Focal® is a trademark from Focal-JMlab®. Non contractual photos. Photos L'Atelier Sylvain Madelon / Shutterstock / Envato Elements - SCAA - 28/06/2023 - V3
In order to evolve, Focal-JMlab® reserves the right to modify the technical specifications and prices of its products without notice. All trade names or trademarks of third parties mentioned in the previous catalog are used for identification purposes only and remain the exclusive property of their respective owners.
Printing: DEUX-PONTS Manufacture d'Histoires - France

